



Specifications



FA400-109



LEAD FREE



Package Includes

- ✓ Faucet
- ✓ FA400 Automator
- ✓ Stainless Steel Hose
- ✓ Mounting Hardware
- ✓ **Batteries Pre-installed**
- ✓ *All the hardware necessary for satisfactory installation*
- ✓ **Please Note:** Faucet Sold Without Drain

Featuring

- ✓ Solid Brass Faucet
- ✓ Lead-Free Construction
- ✓ Matching Electronic Soap Dispenser (Optional)
- ✓ Digital Plug and Play System
- ✓ Resin Encased Control Electronics
- ✓ Battery powered, A/C Option
- ✓ Visible Low Battery Indicator
- ✓ **Available in 22 + Finishes**
- ✓ ADA Compliant
- ✓ 0.25 Gallons Per Cycle Compliant



ANSI A112.18.1M
CSA Standard B125, 1.5 U.S. GPM
NSF/ANSI/CAN61-2022 **Certified**

Optional Equipment

- ✓ Matching Soap Dispenser
- ✓ Lavatory Drain, Grid and Push-Push Type
- ✓ Adjustable Under the Sink Mixing Valve
- ✓ Matching Hole Cap Cover
- ✓ AC Power

Applications

The model FA400-109 is ideal for decorative commercial and industrial applications. Although the model 109 is **ONE OF THE BEST PRICED** electronic faucets available on the market today, this unique faucet is rated **HEAVY DUTY** and features the Faucet Automator model **FA400**. Manufactured to last, the **FA400** employs plug and play digital electronics, hermetically sealed sensor capsule with visible low battery indicator, and employs one of the most reliable SOLID BRASS solenoid valves of any electronic faucet.

Notes



Specifications and Dimensions

MODEL	FA400-109
Spout:	Lead-Free Solid Brass
Power:	4 (AA) Alkaline Batteries or AC Adapter - Optional AC power
Battery life expectancy:	300,000 cycles
Solenoid valve:	6 Volts magnet latching
Working Water Pressure:	1 PSI -100 PSI
Supply Inlet Size:	1/2" NPT Male
Water Temperature Control:	Optional - Choose MAC no. A-12910
Sink Drain:	Optional - Many to choose From
Electronic Soap Dispenser:	Optional - We Recommend PYOS-109 Electronic Soap Dispenser
Sensor Microprocessor:	Digital, Plug and Play
Sensing Range:	2" to 8"
Response Time:	0.3 Second
Shut-Off Delay Time:	3 Second
Maximum Running Time:	30 Seconds
Particle filter size:	50 Mesh
Aerator:	1.5 GPM. Optional 0.5 GPM, 0.35 GPM

All Dimensions in Inches

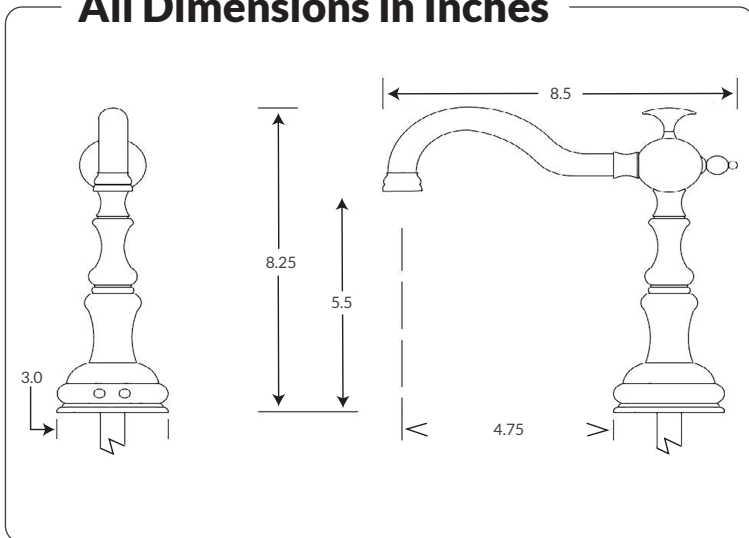

Rough-in

